



Your Dreams, Our Challenge

QUALITATIVE PRODUCT SPECIFICATIONS

**Assessing optical defects & dimensional
tolerances for claims and complaints
purposes**

Issued by:

AGC Flat Glass Czech, a.s., member of AGC Group

Valid from: 1/8/2024

QUALITATIVE PRODUCT SPECIFICATIONS

These **Qualitative Product Specifications** follow on and form part and parcel of the latest version of our General Terms and Conditions. By accepting them you also accept these Qualitative Product Specifications.

Contents

1	QUALITATIVE PRODUCT SPECIFICATIONS	3
2	VISUAL QUALITY OF GLASS.....	4
2.1	How to assess visual quality of glass	4
2.1.1	Glass observation zones for inspection	5
2.1.2	Spot defects in glass	5
2.1.3	Impurities on glass	6
2.1.4	Linear – elongated glass defects.....	7
2.1.5	Printed glass - assessing the visual quality of the print.....	8
2.1.6	Printed Colorbel and Artlite glass characteristics.....	9
3	SIZE SPECIFICATIONS AND OTHER GLASS CHARACTERISTICS.....	10
3.1	Glass size tolerances – length and thickness.....	10
3.1.1	Insulating glass thickness.....	12
3.2	Glass edges – types	14
3.2.1	Edge defects	15
3.3	Glazing with holes and cutouts.....	16
3.3.1	Tolerances for holes and cutouts in glass.....	16
3.4	Heat-treated glass and laminated glass	16
3.4.1	Properties of thermally strengthened and toughened glass and deflection tolerances	16
3.4.2	Labelling heat treated glass - stamps.....	17
3.4.3	Laminated glass - lamination defects tolerance.....	18
3.5	Specific IGU parameters	19
3.5.1	Tolerance for the spacer straightness	19
3.5.2	Primary and secondary sealant parameters	20
3.5.3	Coated glass	21
3.5.4	Fire-resistant IGUs	22
4	GENERAL GLASS QUALITIES.....	23
4.1	Optical and visual qualities.....	23
4.2	Other visual aspects of insulating glass	24

QUALITATIVE PRODUCT SPECIFICATIONS

1 QUALITATIVE PRODUCT SPECIFICATIONS

The quality of glass products shall be assessed according to the requirements set out in relevant harmonised European standards for glass products in the construction industry or pursuant to internal fabrication and quality tolerances defined by AGC herein.

Some tolerances may be different from those defined in the standards below, primarily in order to make them more simple and clearer for customers, and also to reflect current market requirements and more advanced manufacturing technologies at AGC.

Every AGC customer may contact our sales representatives to discuss and get approved different delivery conditions for the glass, depending on the intended application of the given product. If no specific glass application is indicated upon ordering, glass of the quality corresponding to facade glazing for framing will be supplied.

In case of bent insulating glass that AGC does not manufacture directly but through its subcontractors, the manufacturer's quality specifications apply and AGC can provide them to customers upon request.

The main European standards for glass products in construction are as follows:

For basic glass:

EN 572 Glass in building. Basic soda lime silicate glass products

EN 1096 Glass in building - Coated glass

For processed glass:

EN 1279 Glass in building. Insulating glass units

EN 1863 Glass in building - Heat strengthened soda lime silicate glass

EN 12150 Glass in building - Thermally toughened soda lime silicate safety glass

EN 14179 Glass in building - Heat soaked thermally toughened soda lime silicate safety glass

EN 12543 Glass in building - Laminated glass and laminated safety glass

2 VISUAL QUALITY OF GLASS

2.1 How to assess visual quality of glass

Glass shall be inspected from a distance of at least 3 meters from the inside outwards (according to the intended use in the building) and at the most perpendicular angle of view to the glass surface. However, in case of printed glass, there shall be no inspection of the sightline or translucency and this applies to both single sheets and IGUs with at least one printed glass pane in their composition. The glass is assessed in diffused daylight (e.g. cloudy skies), without any direct sunlight or artificial lighting.

If IGUs have to be assessed from the outside then it will be in the installed consideration and viewed from a minimum of 3 m. The viewing angle shall be as perpendicular to the glass surface as possible.

Defects in glass shall not be marked or highlighted in any way. The person authorized to inspect glass can spend a maximum of 1 minute on one square meter of assessed glass.

The following tables with tolerances for evaluation of visual quality shall not apply if the composition includes at least one pane of patterned glass, wired glass, patterned wired glass and anti-burglary glass, bulletproof glass and laminated walk on glass. For this type of glazing the used materials and manufacturing technology has to be considered.

Any defects not visible under these predefined conditions are permissible. If any defects are detected in these conditions, their size, quantity and position on the glass shall be taken into account when assessing the permissibility of such defects; see below for the specific conditions for each type of defect.

QUALITATIVE PRODUCT SPECIFICATIONS

2.1.1 Glass observation zones for inspection

When evaluating the quality of glass, both in individual panes and composite laminated and insulating glass units, three zones are distinguished for which different tolerances of permissible defects apply.

Their layout has been shown in the following figure:

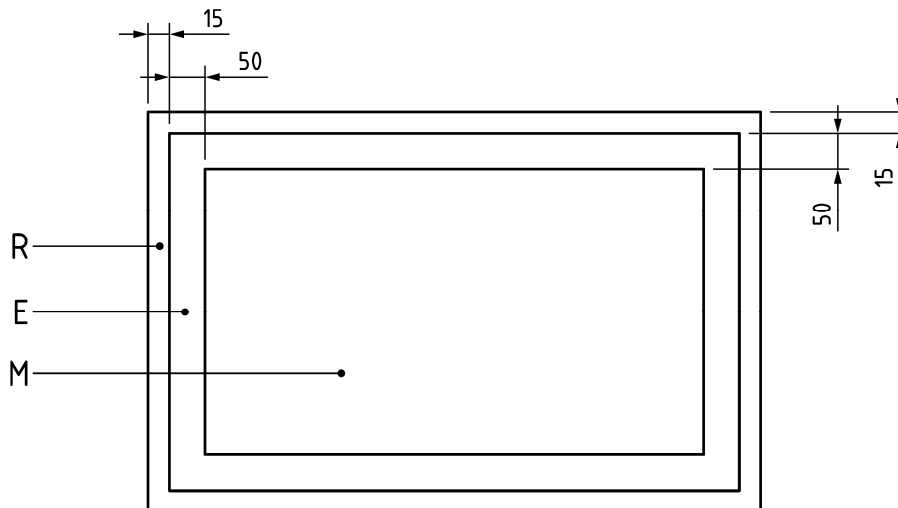

Description:

- R 15 mm wide zone
- E zone along the edge of the visible area 50 mm wide
- M main zone

These zones differ when fire-resistant laminated glass is used, both individually and in the composition of IGUs. In this glass, the R zone is 20 mm wide and the E zone extends up to 5% of the length of the glass edge.

2.1.2 Spot defects in glass

Spot defects disrupt the visual transparency when viewed through the glass, they can be opaque dots (tin marks, stones...), holes in the coating, bubbles, foreign objects or spot inclusions in laminated glass.

The tolerances given in the following table apply to a single pane of glass and to glass composed of a maximum of two panes, both insulating glass and laminated glass. For additional panes in the glass composition, the amount of permissible defects is increased by 25% for each additional pane of glass (it also applies to panes of laminated glass, each additional monolithic pane in insulating glazing is always counted). The number of permissible defects is always rounded up.

QUALITATIVE PRODUCT SPECIFICATIONS

Zone	Defect size (without the deformation field*) (\varnothing in mm)	Pane area S (m ²)			
		$S \leq 1$	$1 < S \leq 2$	$2 < S \leq 3$	$3 < S$
R	All sizes	Without limits			
E	$\varnothing \leq 1$	Permissible if less than 3 spot defects in an area of ≤ 20 cm			
	$1 < \varnothing \leq 3$	4	1 per meter of circumference		
	$\varnothing > 3$	Impermissible			
M	$\varnothing \leq 1$	Permissible if less than 3 spot defects in an area of ≤ 20 cm			
	$1 < \varnothing \leq 2$	2	3	5	$5 + 2/m^2$
	$\varnothing > 2$	Impermissible			

* Note: Deformation field = optically deformed area around the defect

2.1.3 Impurities on glass

Glass impurities means a material that remains on the glass surface in a shape of a spot or a stain. Alternatively, it is a material located on the surface of a spacer frame and inserted elements – here no defects are permissible.

The tolerances given in the following table apply to a single pane of glass and to glass composed of a maximum of two panes, both insulating glass and laminated glass. For additional panes in the glass composition, the amount of permissible defects is increased by 25% for each additional pane of glass (it also applies to panes of laminated glass, each additional monolithic pane in insulating glazing is always counted). The number of permissible defects is always rounded up.

Zone	Dimensions and types (\varnothing in mm)	Pane area S (m ²)	
		$S \leq 1$	$1 < S$
R	All sizes	Without limits	
E	Spots $\varnothing \leq 1$	Without limits	
	Spots $1 < \varnothing \leq 3$	4	1 per meter of circumference
	Spots $\varnothing \leq 17$	1	
	Spots $\varnothing > 3$ and spots $\varnothing > 17$	Maximum 1	
M	Spots $\varnothing \leq 1$	Maximum 3 in each area of $\varnothing \leq 20$ cm	
	Spots $1 < \varnothing \leq 3$	Maximum 2 in each area of $\varnothing \leq 20$ cm	
	Spots $\varnothing > 3$ and spots $\varnothing > 17$	Impermissible	

QUALITATIVE PRODUCT SPECIFICATIONS

2.1.4 Linear – elongated glass defects

Linear or elongated glass defects may have the form of deposits, stains and scratches and occupy a certain length and area. For the most common defect, scratches, there are two basic types, scratches on the glass and scratches on the plated layer.

Scratches on the glass can have the form of a fine mechanical damage to the surface of the glass no thicker than a hair, thus called *a hair scratch*, or can present as sharp mechanical damage, called a coarse scratch. Hair scratches are permissible provided they do not form clusters (a cluster means 3 pieces on the 50 x 50 mm area).

The number of permissible defects depends on the size of a single defect and the total number of all linear defects in the glass.

The tolerances given in the following table apply to a single pane of glass and to glass composed of a maximum of two panes, both for IGUs and laminated glass. For other panes in the glass composition, the number of permissible defects indicated in the note directly in the table is increased.

Zone	Maximum permissible length of linear defects in mm	
	A single defect	All defects
R perimeter 15 mm	Without limitation	
E edge 15 - 65 mm	≤30	≤90
M central	≤15	≤45

Applies to each individual sheet of glass and to glass consisting of 2 sheets, e.g. an IGU or a laminated glass unit. For each additional sheet in the composition the number of permissible defects shall be increased by 25% and rounded up.

Scratches on the plated layer are always accepted based on their size. A scratch in plating does not damage the glass, it is just a small linear defect in plating.

Zone	Maximum permissible length and number of linear defects in mm	
R perimeter up to 15 mm	Unlimited	
E edge 15 - 65 mm	> 75 mm	Permissible when the distance between them is > 50mm
M central	≤ 75 mm	Permissible if the local density does not lead to visual distortions

QUALITATIVE PRODUCT SPECIFICATIONS

2.1.5 Printed glass - assessing the visual quality of the print

The visual quality of the print shall be assessed from a distance of 3 metres and shall not be assessed against light or clearance, which applies both to individual panes and to sheets included in IGUs. The glass is always assessed on the glass side, not on the print side. Save for exceptions listed in the table below, print faults are assessed in all zones in the same way.

If the printed glass is not intended for facade glazing, this must be specified in the order and different terms can be agreed for delivery of such printed glass, if AGC's production capabilities allow. However, the characteristics of coloured glass in silk-print set forth in section 2.1.5 have to be always considered.

Defect / parameter	Specifications / permissible sizes of defects and their incidence	
Spot defects in print (impurities, holes)	$\varnothing \leq 1 \text{ mm}$	unlimited
	$1 \text{ mm} < \varnothing \leq 2 \text{ mm}$	max. 3 defects/m ² of the area
	$\varnothing > 2 \text{ mm}$	not permissible
Linear defects / scratched print	width $\leq 1 \text{ mm}$ and length $\leq 20 \text{ mm}$	unlimited number
	width $\leq 1 \text{ mm}$ and length $\leq 80 \text{ mm}$	max. 2 defects/m ² of the area
	width $\leq 1 \text{ mm}$ and $\leq 2 \text{ mm}$ in length $\leq 80 \text{ mm}$	allowed only in the perimeter of the glass
	width $> 2 \text{ mm}$ or length $> 80 \text{ mm}$	not permissible
Excess print at the edge	$\leq 2 \text{ mm}$	unlimited number
	$> 2 \text{ mm}$	allowed only in the perimeter of the glass
Stripped print at the edge	$\leq 2 \text{ mm}$	unlimited number
	$> 2 \text{ mm}$	not permissible
Excess or stripped print inside the glass surface	$\leq 1 \text{ mm}$	unlimited number
	$1 \text{ mm} < \text{ and } \leq 2 \text{ mm}$	max. 2 defects/m ² of the area
	$> 2 \text{ mm}$	not permissible
Print alignment (against the entire glass S area)	$S \leq 2 \text{ m}^2$	$\pm 2.0 \text{ mm}$
	$2 \text{ m}^2 < S \leq 3 \text{ m}^2$	$\pm 3.0 \text{ mm}$
	$S > 3 \text{ m}^2$	$\pm 4.0 \text{ mm}$

QUALITATIVE PRODUCT SPECIFICATIONS

Total size of the print	For the edge length $\leq 1\,000$ mm	± 2.0 mm
	For the edge length $\leq 1\,000$ mm $\leq 3,000$ mm	± 3.0 mm
	For the edge length $> 3\,000$ mm	± 4.0 mm
Defects in raster	Allowable if upon inspection from the 3-meter distance no irregularities are observed	
Colour deviation ΔE / always for the given glass thickness	$\Delta E \leq 5$ for Float / only in case of samples pre-approved by customer	
	$\Delta E \leq 4$ for Clearvision and Clearlight / only in case of samples pre-approved by customer	

2.1.6 Printed Colorbel and Artlite glass characteristics

Colorbel and Artlite glass is made in screen-printing technology where coloured glass frits are applied over a screen-printing matrix to the glass, which must be subsequently thermally toughened. Due to the high temperature in the tempering furnace, the colour subsequently acquires considerable mechanical and chemical resistance. ARTLITE is partially enamelled glass, COLORBEL is fully enamelled glass.

- a) It is not recommended to apply enamelled glass produced in the screen-printing technology to structures using silicone sealants, as it may possibly show through.
- b) It is not recommended to orient the enamelled side of glass towards the exterior (i.e. position 1).
- c) All developed shades are close to RAL shades and are developed in combination with Planibel clear glass, 6 mm thick (with green tint).
- d) For technological reasons, it is not always possible to obtain the shade absolutely identical with the same colour.
- e) In order to avoid possible differences between the desired and obtained colour (shade, transparency, etc.), we recommend producing a sample first.
- f) Due to the possible occurrence of dark streaks and so-called *star sky* when illuminating printed glass, we do not recommend installing such glass where there is a need to see through it.

QUALITATIVE PRODUCT SPECIFICATIONS

3 SIZE SPECIFICATIONS AND OTHER GLASS CHARACTERISTICS

3.1 Glass size tolerances – length and thickness

The length and offset tolerances for laminated glass and insulating glass shall be assessed based on the length of the edge of the glass.

Glass size - width or height	Single sheet of glass with cut edge	Single sheet of glass with treated edge	IGUs and laminated glass	
Length tolerances in mm			Offset tolerances	
≤ 2000 mm	± 1.0 mm	± 2.0 mm	± 2.0 mm	≤ 2 mm
> 2000 ≤ 3500 mm		± 3.0 mm	± 3.0 mm	≤ 3 mm
> 3500 ≤ 5000 mm			± 4.0 mm	≤ 4 mm
> 5000 mm			± 5.0 mm	≤ 5 mm

For irregular shapes, a tolerance of ± 1° is added for each angle.

If the bevel is less than 30°, it is necessary to make a corner cut for edge stability during further processing. The specific edge cut "d" depends on the "α" angle and the required shape of the glass, and at the same time the minimum requirements for the height of the glass at the cut-off point "x" must also be taken into account, as shown in the figure:

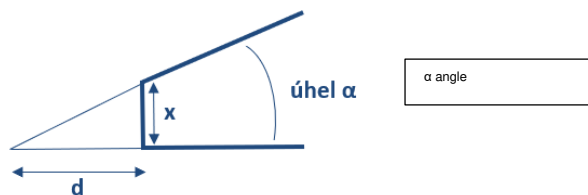

If that is the case, please always contact you AGC sales representative.

The **thickness tolerances** for the base glass are dependent on the nominal thickness of the glass and are shown in the table below. For laminated glass, the sum of tolerances according to the number and thickness of individual panes and the total thickness of the PVB film applies. These are always a multiple of 0.38 mm thickness.

QUALITATIVE PRODUCT SPECIFICATIONS

THICKNESS TOLERANCES FOR THE BASE GLASS				
Nominal thickness	Float	Patterned glass	Polished wired glass	Ornamented wired glass
2mm	± 0.2mm	-	-	-
3-6mm	± 0.2mm	± 0.5mm	± 0.7mm	± 0.7mm
8mm	± 0.3mm	± 0.8mm	-	± 0.8mm
10-12mm	± 0.3mm	± 1.0mm	± 0.9 mm	-1 / + 1.5 mm
15mm	± 0.5mm	-	-	-
19-25mm	± 1.0mm	-	-	-
Total film thickness	THICKNESS TOLERANCES FOR FILM IN LAMINATED GLASS			
≤2mm	permissible deviation may be increased by ± 0.1mm			
>2mm	permissible deviation may be increased by ± 0.2mm			

For example, if the total thickness of the film is < 2 mm, a thickness tolerance of ± 0.1 mm applies to the film (e.g. the thickness of product 6.6.2 can range from 12.26 mm (5.8+0.76-0.1+5.8 mm) to 13.26 mm, (6.2+0.76+0.1+6.2 mm));

Fire-resistant glass thickness tolerances are shown in the table below:

THICKNESS TOLERANCES FOR FIRE-RESISTANT GLASS		
Fire-resistant glass type	Nominal thickness (mm)	Tolerance (mm)
PYROBELITE 7	7.90	≤0.9
PYROBELITE 9 EG	12.06	≤1.5
PYROBELITE 10	12.06	≤1.0
PYROBELITE 12	12.30	≤1.0
PYROBELITE 12 EG	16.10	≤1.0
PYROBEL 8	9.30	≤1.0
PYROBEL 8 EG	13.10	≤1.3
PYROBEL 16	17.30	≤1.0
PYROBEL 16 EG	21.10	≤1.5
PYROBEL 17N	17.80	≤1.6
PYROBEL 17N EG	21.60	≤1.8
PYROBEL 25	26.60	≤2.0

QUALITATIVE PRODUCT SPECIFICATIONS

PYROBEL 25 EG	30.40	≤2.0
PYROBEL 30	30.00	≤2.5
PYROBEL 30 EG	33.70	≤2.8
PYROBEL 30 EG2	37.50	≤3.0
PYROBEL 53N	52.70	≤3.0
PYROBEL 53N EG	56.50	≤3.0
PYROBEL 54	54.00	≤3.0
PYROBEL 54 EG	57.80	≤3.0
PYROBEL 81	81.00	≤3.0
PYROBEL 81 EG	85.00	≤3.0
PYROBEL 19H	19.10	≤1.5
PYROBEL 23H	23.70	≤1.8
PYROBEL 28H	28.40	≤2.0
PYROBEL 33H	33.20	≤2.5

If ordering a different type of fire-resistant glass than those listed in the table above, please contact your AGC sales representative.

3.1.1 Insulating glass thickness

The thickness tolerance for composite insulating glass is different for double and triple glazing and depends also on the composition and type of individual glass.

The actual thickness must be measured as the distance between the outer surfaces of the insulating glass, at all corners and approximately in the middle of the edges. At all these points, the glass must meet the following tolerances:

THICKNESS TOLERANCES FOR COMPOSITE IGUs		
IGU type	IGU consisting only of cooled float glass	IGU includes toughened, laminated or patterned glass
Double glazing	± 1.0 mm	± 1.5 mm
Triple glazing	± 1.4 mm	+ 2.8 mm / - 1.4 mm

QUALITATIVE PRODUCT SPECIFICATIONS





When assessing the thickness of IGUs with fire-resistant glass in composition, the thickness tolerances for fire-resistant glass must be added (see the table above).



Note: For combinations of glass panes other than those listed in the tables, please contact an AGC sales representative.

QUALITATIVE PRODUCT SPECIFICATIONS

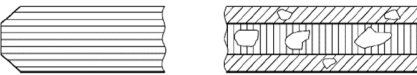
3.2 Glass edges – types

AGC supplies glass with processed and unprocessed edges, as detailed below. Depending on the type of edge, the defects and their allowable size are assessed.

EDGE TYPE	ABBREVIATION	VIEW	DETAILS
Cut edge	KG		Unworked edge
Saw cut	KGG		Unfinished edge with burrs, used in Pyrobel(ite) glass
Arrised / seamed	KGS		Chamfered, edge surface unground
Rough ground	KMG		Chamfer surface bevelled, edge surface ground, unfinished areas permissible
Smooth ground	KGN		Chamfer surface bevelled, edge surface ground, unfinished areas not allowed
Polished	KPO		Chamfers polished, edge surface ground, unpolished areas not allowed

<p>Chamfer shape and tolerances are shown in the figure below. Standard angle is $45^\circ \pm 5^\circ$ with $1.5 \text{ mm} \pm 1 \text{ mm}$ in size.</p>	<p>In case of a C-shape edgework (a pencil edge) no size tolerances have been set out. For more information, please contact an AGC sales representative.</p>
	

Bevelled corners are standard on glass with ground and polished edge, other requirements must be specified when ordering.

QUALITATIVE PRODUCT SPECIFICATIONS

3.2.1 Edge defects

External shallow edge damage or shell fractures, which do not affect the glass strength and which do not exceed the edge sealing width, are permissible. Inner shell fractures without loose debris, which are filled with sealing material, are permissible.

Tolerances for shells depend on the type of edgework. This applies to holes and cut outs as well.

EDGEWORK WITH SHELLS	
Clean cut and saw cut	max width = glass thickness (-)1 mm; max. depth of 1/4 of glass thickness, no limit to length and number
Chamfered edge, rough ground	max width of 3 mm, max length 6 mm, max depth of 1/4 of glass thickness, number unlimited
Smooth ground edgework	max width and length 0.4 mm – number unlimited
Polished edge	max width and length 0.2 mm – number unlimited
SHELLS AROUND HOLES, CUTOUTS ASSESSED ACCORDING TO EDGEWORK	
Chamfered edge, rough ground	max width of 3 mm, max length 6 mm, max depth of 1/4 of glass thickness, number unlimited
Smooth ground edgework	max width and length 0.4 mm – number unlimited
Polished edge	max width and length 0.2 mm – number unlimited
SHELLS AROUND THE RECESSED HOLE	
View side	not permissible
Non-view side	max width and length 2 mm – number unlimited

QUALITATIVE PRODUCT SPECIFICATIONS

3.3 Glazing with holes and cutouts

3.3.1 Tolerances for holes and cutouts in glass

Tolerances for hole diameter in mm	
Nominal hole diameter in mm	
$4 \leq \varnothing \leq 20$	$\pm 1,0$ mm
$20 \leq \varnothing \leq 100$	$\pm 2,0$ mm
$\varnothing > 100$	$\pm 3,0$ mm
Hole and cutout placement tolerance [mm]	
All glass types and sizes	$\pm 2,0$ mm
Tolerance of hole offset (when drilling from both sides)	
All glass types and sizes	≤ 1.0 mm
Hole offset tolerances for laminated glass	
All glass types and sizes	≤ 2.0 mm

3.4 Heat-treated glass and laminated glass

When using thermally toughened glass, a risk of spontaneous fractures caused by nickel sulfide inclusions is possible even after some time, even as long as a couple of years. To mitigate this phenomenon it is recommended to run a heat soak test according to EN 14179 standard. It helps reduce significantly the risk of spontaneous cracks, however, it cannot prevent it completely. It is a phenomenon typical for glass that cannot be avoided. Even after the heat soak test the probable risk of a fracture per each 400 tonnes of heat soaked glass remains.

3.4.1 Properties of thermally strengthened and toughened glass and deflection tolerances

During heat strengthening (according to EN 1863) and heat toughening (according to EN 12150) and the subsequent Heat Soak Test (EN 14179), the flatness and visual deformation of the glass is affected. This cannot be prevented and cannot be considered a defect. Typical qualities of heat-treated glass have been discussed in section 4.1.

For wave distortions the limits have been defined based on the type of glass and the heat treatment applied, as shown in the following table.

QUALITATIVE PRODUCT SPECIFICATIONS

Maximum total deflection	
Heat strengthened float glass	3 mm / m
Thermally toughened (tempered) float glass	3 mm / m
Decorative glass	4 mm / m
Laminated glass / with float in composition	2 mm / m
Laminated glass / with at least 1 toughened or strengthened glass in composition and fire-resistant glass	3 mm / m
Maximum local deflection, the so-called roller wave distortion in the glass surface	
Heat strengthened float glass	0.3 mm / 300 mm
Thermally toughened (tempered) float glass	0.3 mm / 300 mm
Decorative glass	0.5 mm / 300 mm
Maximum entry and exit wave (at the edge of the glass)	
Heat strengthened float glass	0.3 mm / 300 mm
Thermally toughened (tempered) float glass	0.3 mm / 300 mm
Decorative glass	0.5 mm / 300 mm

The total deflection parameter is not defined for IGUs and thus it is not assessed. The deflection of individual pane or laminated glass is always evaluated.

3.4.2 Labelling heat treated glass - stamps

All heat-treated glass intended for construction purposes shall be stamped with the standard number and manufacturer's identification.

Depending on the specific heat treatment standard and any HST test, if applicable, the stamps on the glass are identified as follows: EN 12150-1 for tempered glass, EN 1863-1 for heat-strengthened glass and EN 14179-1 for heat-strengthened glass with Heat Soak Test.

Glass supplied by AGC Processing Teplice a.s. is marked with a standard black text stamp with a text height of 2.4 mm, placed at the edge of the glass so that the stamp is not visible when placed in the IGU.

If the stamp is required in the see through area, a round stamp is attached in black with 20 mm in diameter.

Standard tolerances for stamp position are ± 3 mm.

QUALITATIVE PRODUCT SPECIFICATIONS

Text stamp by the glass edge / standard marking	Round stamp in the see through area / on demand
<p>AGC PT EN1863-111-8081NE TP CGA</p> <p>AGC PT EN12150-111-05121NE TP CGA</p> <p>AGC PT EN14179-111-9141NE TP CGA</p>	

Valid stamps from other AGC plants will be shared if requested.

3.4.3 Laminated glass - lamination defects tolerance

Permissible laminated glass defects	
Film overflow and run-in without edge difference	1 mm maximum, no limits to the length
Delamination – cut and chamfered edge	up to 5 mm from the edge, up to 5 mm long
Delamination – ground and polished edge	not permissible
Delamination around the hole	up to 15 mm from the edge, up to 5 mm long, number unlimited

QUALITATIVE PRODUCT SPECIFICATIONS

3.5 Specific IGU parameters

3.5.1 Tolerance for the spacer straightness

In insulating double glass, the tolerance of the spacer straightness is 4 mm up to the length of 3.5 m, and 6 mm for longer glass. The permissible deviation of a spacer(s) relative to the straight parallel glass edge or another spacer (e.g. in triple glazing) is 3 mm up to the length of 2.5 m. For longer edges the deviation of 6 mm is permissible.

Spacer frame tolerance		
IGU type	A straight / B parallel (mm)	Edge dimensions of insulating glass
Double glazing	4 mm	≤ 3500 mm
	6 mm	> 3500 mm
Triple glazing	3 mm	≤ 2500 mm
	6 mm	> 2500 mm

Examples of spacer deviations

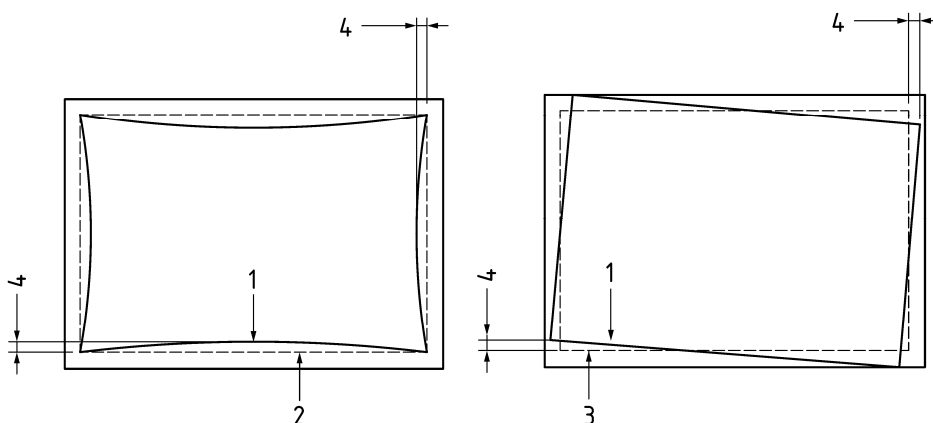

Legend

Spacer

Theoretical shape of a spacer

Theoretical position of a spacer

Deviation

QUALITATIVE PRODUCT SPECIFICATIONS

3.5.2 Primary and secondary sealant parameters

The primary and secondary sealant first and foremost needs to maintain functional properties of the insulating glass units. To ensure proper functionality parameters AGC has defined sealant quality tolerances, presented in the table below.

Assessing the visual parameters of the sealant is not a common standard and as such has to be indicated specifically in the order. This is mainly the case of structural glazing, where the edges of the IGU are well visible around the entire perimeter. The standard embedment of the spacer frame is 4 mm for the use of polyurethane and polysulphide, and 6 mm for embedment using silicone as a secondary sealant. Other embedment heights always depend on the agreement between AGC and the customer.

Sealant quality	
Spacer bottom edge recess	± 2.0 mm
Primary sealant (butyl) height after moulding	at least 3 mm, under certain circumstances, 3 - 1 mm can be tolerated, but interruption of the butyl is inadmissible
Butyl in the field of view (from the frame to the glass)	maximum of 2 mm
Butyl is not bonded with external sealant (air inclusion)	width ≤ 1 mm – unlimited around the perimeter
	1 mm < width ≤ 2 mm – length of up to 100 mm max
	width > 2 mm - not allowable
Secondary sealant height against the edge of the IGU	± 2.0 mm
The tolerance of the placement of the grid in relation to the edge of the insulating glass (location of individual grid)	± 3 mm
Spacer defects (per 1 pc of IGU) - free particles, dirt or permanent spots	max. 4 pcs, each no larger than ø 1 mm
Spilled molecular sieve - free particles on the spacer frame in one chamber of IZ glass	permitted up to a maximum number of 10 pcs per 1m of the bottom edge of the glass
Tolerance for U-profile alignment in external sealant (details in the picture below)	
Position of the U-profile/ misalignment along the perimeter	± 25 mm
U-profile position inside the chamber	± 1.0 mm (with the minimum distance from the glass of 3 mm at least on one side)

QUALITATIVE PRODUCT SPECIFICATIONS

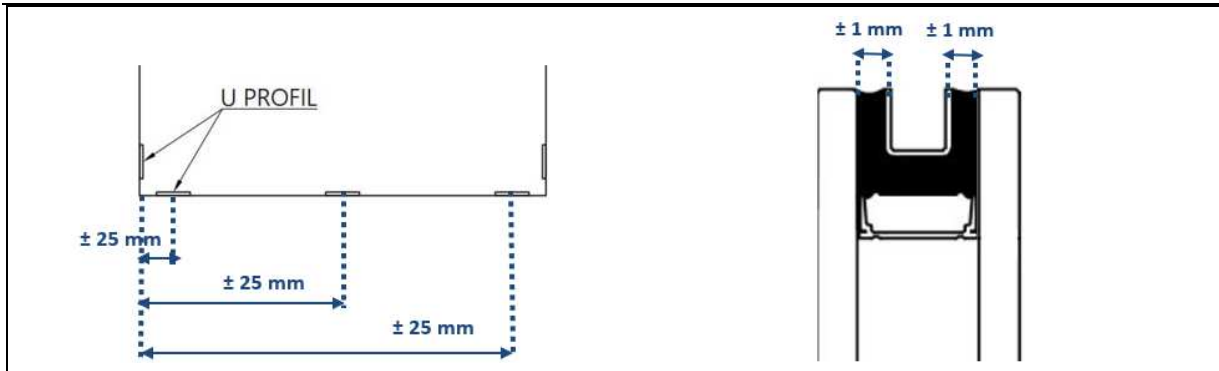

3.5.3 Coated glass

When manufacturing insulating glass, in order to preserve the functional properties, it is necessary to grind off the coating along the edge of the glass so that the secondary sealant does not interfere with the surface of the coated glass. Due to possible dimensional variability during the processing and production of insulating glass, colour effects may occur when a frame with a primary sealant is applied to the glass, depending on the extent to which the primary sealant interferes with the plated layer or the deburred surface.

These effects can be observed on the glass as white or coloured lines, and the aim is to minimise them. However, as a result of the above, AGC cannot guarantee the spacer will remain aligned along the entire perimeter of the glass; on the contrary, at the corners and 150 mm around the corners even higher deviations may occur.

Examples of colour effects after stripped plating		
<p>x = 0 mm, no white or colour lines on the glass</p>	<p>Visible distinctive white line x mm high</p>	<p>Visible distinctive coloured line (usually blue) x mm high</p>

QUALITATIVE PRODUCT SPECIFICATIONS

3.5.4 Fire-resistant IGUs

When installing fire-resistant IGUs, special care is required. The glass is protected against moisture penetration with aluminium adhesive tape. When installing IGUs with fire-resistant glass, the correct exterior/interior orientation has to be ensured. The glass is always properly marked.

This is why AGC wishes to highlight other defects that may not be subject to claims and complaints:

- a) Damaged protective adhesive tape, which is an integral part of the product;
- b) Exceeded temperature range between - 40 °C and 50 °C;
- c) Water penetration to the edge of the fire glass;
- d) Incorrect orientation of the insulating glass during glazing - fire-resistant glass exposed to long-term solar and UV radiation;
- e) The position of the defined bottom edge of the insulating glass replaced with Pyrobel T during glazing - if the bottom edge of the glass is not oriented properly, air can get inside the glass and form bubbles in the gel.

4 GENERAL GLASS QUALITIES

4.1 Optical and visual qualities

- a) **Natural colour of clear glass:** clear glass has a very faint green appearance, especially at the edges. It becomes more pronounced with greater glass thickness.
- b) **Thermally toughened and heat soaked thermally toughened glass:** The mechanical properties of thermally toughened soda lime silicate safety glass do not change when heated to at least 250 °C and are not affected by temperatures below zero. Thermally toughened soda lime silicate safety glass is able to withstand sudden temperature changes in both directions and temperature differences up to 200K.
- c) **Heat strengthened glass:** The mechanical properties of heat strengthened soda lime silicate glass do not change when gradually heated to at least 200 °C and are not affected by temperatures below zero. Thermally toughened soda lime silicate safety glass is able to withstand sudden temperature changes in both directions and temperature differences up to 100 K.
- d) **Spontaneous explosion of thermally toughened soda lime silicate safety glass:** The presence of NiS inclusion is an inherent property of thermally toughened glass and may lead to spontaneous glass explosion. The manufacturer is not liable for any damage caused by this property of heat-treated glass. Spontaneous explosion of glass can be minimized by performing the Heat Soak Test (HST).
- e) **Optical deformation:** It is a phenomenon of heat-treated glass where the surface deformation is visible in reflection along with small imprints (pressure marks) into the glass surface.
- f) **Anisotropy (irisation):** During the toughening process, surfaces with different stresses in the glass cross-section are formed. When thermally toughened soda lime silicate safety glass is viewed in polarized light, the stress areas appear as coloured zones, sometimes known as *leopard spots*. Polarized light also occurs in normal daylight. The birefringence effect is more noticeable when viewed at an acute angle.

QUALITATIVE PRODUCT SPECIFICATIONS

4.2 Other visual aspects of insulating glass

Certain physical phenomena may appear on the glass surface and should not be taken into account when assessing the image quality. Those are not considered defects.

a) Actual colour

Differences in colour appearance may be caused by the contents of iron oxides in glass, the coating process, the coating itself, variations in the glass thickness and the insulating glass construction. They cannot be prevented.

b) Differences in the insulating glass colour

Facades made of insulating glass containing coated glass may have different shades of the same colour. This effect can be amplified when viewed at an angle. Possible causes of the colour difference include slight changes in colour of the substrate to which the coating is applied and slight changes in the thickness of the coating itself.

An objective assessment of colour differences can be made according to ISO 11479-2.

c) Brewster's Fringes – interference colouration:

When glass pane surfaces are nearly perfectly parallel and the surface quality is high, interference colouration of the insulating glass occurs. These are fringes of variable colour resulting from the light spectrum decomposition. If the source light is the sun, colours vary from red to blue. This phenomenon is not considered a defect, it is the result of the insulating glass construction.

d) Newton's Rings

This optical phenomenon occurs in **defective insulating glass** where two glass panes touch or almost touch in the middle. This optical phenomenon exhibits as a set of concentric coloured rings centred at the point of contact / near contact of two glass panes. The rings are roughly circular or elliptical.

e) Glass colouring caused by different stresses in the glass cross-section

Some processed glass also has a colour characteristic for a product which has been toughened or heat-strengthened, see EN 12150-1 or EN 1863-1. **This is not a glass defect.**

QUALITATIVE PRODUCT SPECIFICATIONS

f) Climatic load

The gas used to fill the insulating glass retains the atmospheric pressure level on the day of manufacture. Since the insulating glass unit is hermetically sealed to prevent moisture penetration, changes in atmospheric pressure at the installation site cause the insulating glass unit to either collapse or bulge individual panes of glass.

Atmospheric pressure is a parameter that cannot be managed either during manufacture or at the installation site and naturally decreases with altitude, while its value is constantly changing. The risk of climate load also increases with altitude. When other factors such as heat from the sun, wind gusts and sudden changes in atmospheric pressure occur simultaneously, they can cause excessive climatic stress and the glass will crack.

We therefore recommend that our customers always inform us in advance about the installation of insulating glass units at altitudes over 700 m above sea level.

The aspect ratio of the glazing is yet another factor that impacts the risk of spontaneous glass breakage. The higher the aspect ratio, the greater the risk. The spontaneous glass breakages may occur for the 1:4 aspect ratio.

The climatic load depends also on the length of the shorter edge itself. If the double glazing has a shorter side of less than 500 mm and the triple glazing has a shorter side of less than 700mm, the risk of climate shock increases again.

The thickness of the spacer used also plays a role here. In IGUs with spacers 16 mm thick or more, the inert gas used inside the cavity expands under climatic load and thus puts a load on the enamel itself until the glass breaks.

The climatic fracture itself occurs when several of the above factors combine.

g) Glass deflection caused by temperature and barometric pressure fluctuations

Fluctuations of temperature in the air or a gas-filled cavity and fluctuations of barometric pressure of atmosphere and altitude cause the air or gas to shrink or expand in the cavity, resulting in deflection of glass panes and, thus, distortion of the reflected image. These unavoidable deflections fluctuate over time. Their size depends partly on the stiffness and size of the glass pane and also on the width of the cavity. These deflections are significantly reduced by small dimensions, glass thickness and/or small cavities. **This is not a glass defect.**

h) Condensation on external surfaces

External condensation on insulating glass can occur both indoors and outdoors. If it occurs indoors, it is usually caused by high humidity in the room, along with low

QUALITATIVE PRODUCT SPECIFICATIONS

outside temperature. Kitchens, bathrooms and other areas with high humidity are particularly sensitive. If it occurs outdoors, the condensation is caused by the overnight loss of heat of the outer glass surface emitted by infrared radiation towards the clear sky, together with the high humidity of the outside atmosphere, but never by rain. These phenomena **are not considered glass defects**, they are caused by atmospheric conditions.

i) Natural colour of clear glass

Clear glass has a very faint green appearance, especially at the edges. It becomes more pronounced with greater glass thickness. **This is not a glass defect.**

AGC would also like to highlight other possible defects that are not eligible for claims:

j) Cracks in glass

Glass overloading caused by force due to impact, thermal stress, frame structure movements or contact with the frame may result in a glass fracture, which is not considered a warranty defect. If the glass stress is present during its processing (cutting, grinding), such processing would not be successful.

k) Grating in the glass interspace

Due to temperature fluctuations, the length of the glass partition crosspieces changes, causing clattering sounds that can never be completely avoided, and therefore it is not considered a warranty defect.

l) Thermal shock

A spontaneous phenomenon which may cause the glass to break without any visible external factors at play.

The thermal shock is distinguished by the typical fracture in glass (see the image below). The fracture (3) usually leads from the glass edge (1) perpendicularly.

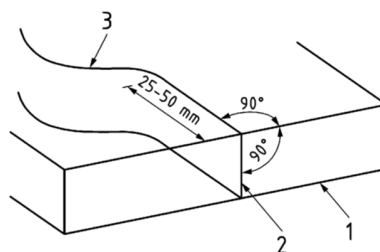

NOTE: The amount of thermal stress in a glass pane depends on the temperature difference between the hottest part (often the central part exposed to sunlight) and

QUALITATIVE PRODUCT SPECIFICATIONS

the coldest part (often near the edges and close to the frame). Sunlight affecting the glass absorbs the heat and thus has the tendency to expand glass, causing tensile stress on the cooler edge. This can cause local cracks to propagate, leading to the fracture of the glass itself. The defects observed on the edge of the glass pane and consequently the degree of edgework itself affect the resistance to thermal fracture. The edge strength can be calculated according to different degrees of surface finish.

The risk of thermal shock with cooled glass is significantly higher (already at a thermal difference of approx. 35 °C) compared to thermally strengthened glass (at a temperature difference of approx. 100°C) and tempered glass (at a temperature difference of approx. 200°C).

Applying various films on glass, partial shading of glass with various objects, such as dark furniture, half-closed blinds, curtains etc., should be considered as risky. It is also necessary to avoid situations preventing free air flow between the glass and the rest of the room. The risk assessment of thermal stress shall be carried out by the designer.

m) Wettability of insulating glass

The wettability of the surface on the outer side of insulating glass may differ due to imprints of rollers, fingerprints, labels, residues of smoothing agents, etc. On a wet glass surface caused by dew, rain or water during cleaning, different wettability may become visible.